



Laboratory Procedure Manual

Analytes: **Perfluoroalkyl and Polyfluoroalkyl Substances**

Matrix: **Serum**

Method: **Online Solid Phase Extraction-High Performance Liquid Chromatography-Turbo Ion Spray-Tandem Mass Spectrometry (online SPE-HPLC-TIS-MS/MS)**

Method No: **6304.09**

As performed by:

**Organic Analytical Toxicology Branch
Division of Laboratory Sciences
National Center for Environmental Health**

Contact:

**Julianne Botelho, Ph.D.
Phone: 770.488.7391
Email: gur5@cdc.gov**

**James L. Pirkle, M.D., Ph.D.
Director, Division of Laboratory Sciences**

Important Information for Users

The Centers for Disease Control and Prevention (CDC) periodically refines these laboratory methods. It is the responsibility of the user to contact the person listed on the title page of each write-up before using the analytical method to find out whether any changes have been made and what revisions, if any, have been incorporated.

Public Release Data Set Information

This document details the Lab Protocol for testing the items listed in the following table:

DATA FILE NAME	VARIABLE	ANALYTE NAME
PFAS_J	LBXPFDE	Perfluorodecanoic acid (PFDeA) (ng/mL)
	LBXPFHS	Perfluorohexane sulfonic acid (PFHxS) (ng/mL)
	LBXMPAH	2-(N-methylperfluorooctanesulfonamido)acetic acid (Me-PFOSA-AcOH) (ng/mL)
	LBXPFNA	Perfluorononanoic acid (PFNA) (ng/mL)
	LBXPFUA	Perfluoroundecanoic acid (PFUA) (ng/mL)
	LBXNFOA	n-perfluorooctanoic acid (n-PFOA) (ng/mL)
	LBXBFOA	Branch perfluorooctanoic acid isomers (Sb-PFOA) (ng/mL)
	LBXNFOS	n-perfluorooctane sulfonic acid (n-PFOS) (ng/mL)
	LBXMFOA	Perfluoromethylheptane sulfonic acid isomers (Sm-PFOS) (ng/mL)

1. Clinical Relevance and Summary of Test Principle

a. Clinical Relevance

Some per- and polyfluoroalkyl substances (PFAS), including perfluorooctane sulfonate (PFOS) and perfluorooctanoate (PFOA), persist in humans and the environment and have been detected worldwide in wildlife^{1, 2}. Exposure to PFOS and PFOA in the general population is also widespread, although demographic, geographic, and temporal differences exist.³⁻¹⁵ In animals, exposure to PFOS and PFOA is associated with adverse health effects¹⁶⁻¹⁸ albeit at serum concentrations orders of magnitude higher than the concentrations observed in the general population.^{19, 20} PFOS was used in a wide variety of industrial and consumer products including protective coatings for carpets and apparel, paper coatings, insecticide formulations, and surfactants. In 2000, 3M, the sole manufacturer of PFOS in the United States and the principal manufacturer worldwide, announced that it was discontinuing its perfluorooctanyl chemistries, including PFOS. Shortly after, EPA also identified possible related concerns with respect to PFOA and fluorinated telomers. PFOA has been used primarily to produce its salts which are used in the production of fluoropolymers and fluoroelastomers. These polymers are used in many industrial and consumer products, including soil, stain, grease, and water-resistant coatings on textiles and carpet; in the automotive, mechanical, aerospace, chemical, electrical, medical, and building/construction industries; personal care products; and non-stick coatings on cookware.

The electrochemical fluorination (ECF) manufacturing method used from the 1950s until the early 2000s to produce PFAS including PFOA, and PFOS and its precursors yielded branched and linear isomers. By contrast, another method, telomerization, produces almost exclusively linear compounds²¹. The structural isomer patterns of PFOA and PFOS in humans may be useful for understanding routes and sources of exposure.

In addition to PFOA, PFOS and other so-called “legacy” PFAS, this method includes two PFAS alternatives, perfluoroalkyl ether carboxylic acids (PFECAs) and perfluoroalkyl ether sulfonic acids (PFESA). The two PFECAs introduced as replacements for long-chain legacy PFAS are the ammonium salt of 2,3,3,3-tetrafluoro-2-(1,1,2,2,3,3,3-heptafluoropropoxy)-propanoate (GenX) and ammonium salt of 4,8-dioxo-3H-perfluorononanoate (ADONA).^{22, 23} PFECAs have shorter elimination half-lives in animals than PFOA.²⁴ However, previous research suggested toxicity of GenX and ADONA in experimental animals, with a similar mode of toxicity as that of PFOA.²³ Furthermore, these fluorinated alternatives cannot be metabolized in biota and may have a similar high affinity to proteins, resulting in a potential for bioaccumulation.²³ Of further concern, the detection of GenX in surface waters and drinking water²⁵⁻²⁷ has raised

concerns about potential health implications. A chlorinated PFESA (2-[(6-chloro-1,1,2,2,3,3,4,4,5,5,6,6-dodecafluorohexyl)oxy]-1,1,2,2-tetrafluoroethanesulfonic acid potassium salt (9Cl-PF, also known as F-53B) has been used in the chrome plating industry in China for decades²³ and has been recently detected at relatively high concentrations in the environment and biota in China.^{28, 29} In vitro, in vivo, and in silico studies suggest that 9Cl-PF can disrupt the thyroid endocrine system at environmentally relevant concentrations.³⁰ Documented uses of 9Cl-PF outside China are not known, but the persistence and transport potential of 9Cl-PF raise some concerns about a future global contamination problem²⁹ and human exposure to PFECAs through contaminated drinking water.

b. Test Principle

Online solid phase extraction coupled to high performance liquid chromatography-turboionspray ionization-tandem mass spectrometry (online SPE-HPLC-TIS-MS/MS) is used for the quantitative detection of the PFAS listed in Table 1, and the analytical method used has been previously published³¹. Briefly, after dilution with formic acid, one aliquot of 50 µL of serum is injected into a commercial column switching system allowing for concentration of the analytes on solid-phase extraction column. Separation of the analytes from each other and from other serum components is achieved with high-performance liquid chromatography. Detection and quantification are done using negative-ion TurbolonSpray ionization, a variant of electrospray ionization, tandem mass spectrometry. This method allows for rapid detection of these PFAS in human serum with limits of detection in the low parts per billion (ppb or ng/mL) range.

Table 1. Codes for compounds measured in this method

Count	Code	Compound
1	FOSA	Perfluorooctane sulfonamide
2	MeFOSAA	2-(<i>N</i> -Methyl-perfluorooctane sulfonamido) acetate
3	EtFOSAA	2-(<i>N</i> -Ethyl-perfluorooctane sulfonamido) acetate
4	PFHxS	Perfluorohexane sulfonate
5	PFHpS	Perfluoro-1-heptane sulfonate
6	n-PFOS	<i>N</i> -Perfluorooctane sulfonate
7	Sm-PFOS	Sum of perfluoromethylheptane sulfonate isomers
8	PFHxA	Perfluorohexanoate
9	PFHpA	Perfluoroheptanoate
10	n-PFOA	<i>n</i> -Perfluorooctanoate
11	Sb-PFOA	Sum of branched perfluorooctanoate isomers
12	PFNA	Perfluorononanoate
13	PFDA	Perfluorodecanoate

14	PFUnDA	Perfluoroundecanoate
15	GenX	2,3,3,3,-Tetrafluoro-2-(1,1,2,2,3,3,3-heptafluoropropoxy)-propanoate
16	ADONA	Dodecafluoro-3H-4,8-dioxanoate
17	9CI-PF	9-Chlorohexadecafluoro-3-oxanonane-1-sulfonate

c. Analyte structures

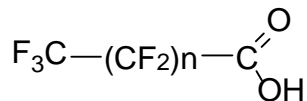

n=4 PFHxA
n=5 PFHpA
n=6 n-PFOA
n=7 PFNA
n=8 PFDA
n=9 PFUnDA

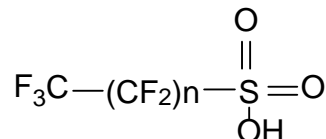

n=5 PFHxS
n=6 PFHpS
n=7 n-PFOS

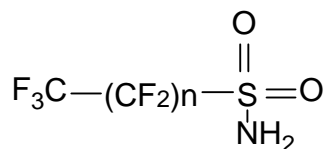

n=7 FOSA

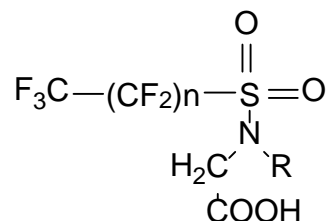

n=7, R=Me MeFOSAA
n=7, R=Et EtFOSAA

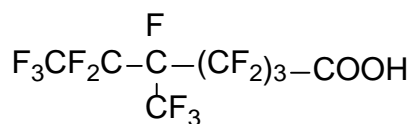

Sb-PFOA

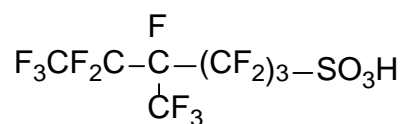

Sm-PFOS



GenX

9CI-PF

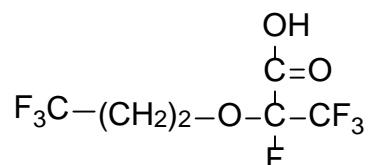

ADONA

2. Safety Precautions

a. Reagent Toxicity or Carcinogenicity

Some of the reagents used are toxic. Special care should be taken to: 1) Avoid contact with eyes and skin, 2) avoid use of the organic solvents in the vicinity of an open flame, and 3) use solvents only in well-ventilated areas.

Note: Safety Data Sheets (SDS) for the chemicals and solvents used in this procedure can be found in a binder in the laboratory and online at the following websites: <https://chats.cdc.gov/Pages/Home> (CDC intranet) or <http://www.msds.com/>. Laboratory personnel are advised to review the SDS before using chemicals.

Care should be exercised in the handling of all chemicals.

b. Radioactive Hazards

None.

c. Microbiological Hazards

The possibility of being exposed to various microbiological hazards exists. Appropriate measures (i.e., universal precautions) should be taken to avoid any direct contact with biological specimens (i.e., use gloves, laboratory coats, safety glasses, chemical or biological hoods). Any residual biological material should be appropriately discarded and prepared for autoclaving after analysis is completed. All disposable laboratory supplies must also be placed in an autoclave bag for disposal. The Hepatitis B vaccination series is recommended for health care and laboratory workers who are exposed to human fluids and tissues. Laboratory personnel who handles human fluids and tissues is required to take the "Bloodborne Pathogens Training" course offered at CDC to ensure proper compliance with CDC safe workplace requirements.

d. Mechanical Hazards

Minimal mechanical hazards are present when performing this procedure using standard safety practices. Laboratorians should avoid any direct

contact with the electronics of the mass spectrometer, unless all power to the instrument is off. Generally, only qualified technicians should perform the electronic maintenance and repair of the mass spectrometer. Contact with the heated surfaces of the mass spectrometer (e.g., interface) should be avoided.

e. Protective Equipment

Standard safety protective equipment should be utilized when performing this procedure. This includes lab coat, safety glasses, durable gloves (e.g., nitrile or vinyl), and/or a chemical fume hood or biological safety cabinet.

f. Training

Training and experience in the use of a triple quadrupole mass spectrometer and the online SPE extractor should be obtained by anyone using this procedure. Formal training is not necessary; however, an experienced user should train all the operators.

g. Personal Hygiene

Care should be taken in handling any biological specimen. Routine use of gloves and proper hand washing should be practiced. No food or drink is allowed in laboratory areas.

h. Disposal of Wastes

Solvents and reagents are disposed of in an appropriate container clearly marked for waste products and temporarily stored in one of the chemical fume hoods. Containers, glassware, etc., that come in direct contact with the specimen are either autoclaved or decontaminated with a decontaminating solution like 10% bleach. Contaminated analytical glassware is treated with bleach, washed and reused; disposable labware is autoclaved before disposal. To ensure proper compliance with CDC requirements, laboratory personnel are required to attend annual hazardous waste disposal courses.

3. Computerization; Data-System Management

a. Software and Knowledge Requirements

Mass spectrometry data are collected, stored, and processed using Analyst and MultiQuant™ software. The raw data (for example, peak area, peak height, retention time, analyte name, MRM transition name) are exported from the instrument and uploaded into the database. The database is stored on a network drive; it may also be backed up in

additional archive locations. Knowledge and experience with these software packages (or their equivalent) are required to utilize and maintain the data management structure.

b. Sample Information

Sample information is read into the instrument and the database either manually or via a barcode reader.

c. Data Maintenance

Raw instrument files are regularly backed up onto an external hard drive which is periodically backed up to a network drive. Sample and analytical data are checked after being entered into the database for transcription errors and overall validity. The database containing sample results is routinely backed up onto a network drive

4. Procedures for Collecting, Storing, and Handling Specimens; Criteria for Specimen Rejection

a. Sample Collection and Storage

Follow recommended phlebotomy practices for the collection of blood and separation of blood serum. Preferably, a minimum of 0.5 mL of serum (plasma may also be used) should be placed in standard collection containers, refrigerated as soon as possible, and transferred to labeled containers for storage. Serum should be stored frozen, preferably in polypropylene or polyethylene containers. Glass containers may be used if the specimens are to be analyzed for other environmental chemicals for which storage in plastic may be a problem. Teflon® coated materials should be avoided.

b. Sample Handling

In general, serum specimens should be shipped or transported cold (dry ice, ice or blue ice can be used). Special care must be taken in packing to protect vials from breakage during shipment.

Before analysis, samples are thawed, vortexed, aliquoted, and the residual specimen is refrozen and stored. The integrity of samples thawed and refrozen several times doesn't appear to be compromised.

c. Criteria for Specimen Rejection

Specimens can be rejected if tubes/vials leaked, are broken, appear compromised or tampered with, or hold inadequate volume for analysis.

5. Procedures for Microscopic Examinations; Criteria for Rejecting Inadequately Prepared Slides

Not applicable for this procedure.

6. Preparation of Reagents, Calibration (Standards), Controls, and All Other Materials; Equipment and Instrumentation

a. Reagents and Sources

Methanol (MeOH), acetonitrile, and water were HPLC grade purchased from Fisher Scientific (Pittsburgh, PA). Formic acid (99%) was purchased from EM Science (Gibbstown, NJ). Acetic acid (glacial) was purchased from J.T. Baker (Phillipsburg, NJ). The compounds in Table 2 and isotopically labeled compounds in Table 3 were purchased from Wellington Laboratories (Guelph, Ontario) except ¹⁸O₂-perfluorooctane sulfonamide (¹⁸O₂-FOSA), which was purchased from RTI Laboratories (RTP, NC). All reagents were used without further purification. Materials and reagents with similar specifications may be used.

Table 2. Typical concentration of native standard solutions

Count	Code	Compound name	Typical neat concentration (µg/mL)
1	FOSA	Perfluorooctane sulfonamide	50.0
2	MeFOSAA	2-(N-Methyl-perfluorooctane sulfonamido) acetate	50.0
3	EtFOSAA	2-(N-Ethyl-perfluorooctane sulfonamido) acetate	50.0
4	PFHxS	Perfluorohexane sulfonate	50.0
5	PFHpS	Perfluoro-1-heptanesulfonate	50.0
6	n-PFOS	N-Perfluorooctane sulfonate	50.0
7	*Sm-PFOS	Perfluoro-5-methylheptanesulfonate (P5MHpS)	1.96
8	PFHxA	Perfluorohexanoate	50.0
9	PFHpA	Perfluoroheptanoate	50.0
10	n-PFOA	n-perfluorooctanoate	50.0
11	*Sb-PFOA	Perfluoro-5-methylheptanoic acid (P5MHpA)	1.00
12	PFNA	Perfluorononanoate	50.0
13	PFDA	Perfluorodecanoate	50.0
14	PFUnDA	Perfluoroundecanoate	50.0
15	GenX	2,3,3,3-Tetrafluoro-2-(1,1,2,2,3,3,3-heptafluoropropoxy)-propanoate	50.0
16	ADONA	Dodecafluoro-3H-4,8-dioxanoate	50.0
17	9CI-PF	9-Chlorohexadecafluoro-3-oxanonane-1-sulfonate	50.0

Table 3. Typical concentration of isotopically labeled internal standards

Count	Code	Compound name	Typical neat concentration (µg/mL)
1	¹⁸ O ₂ -FOSA	¹⁸ O ₂ -Perfluorooctane sulfonamide	powder
2	D ₃ -MeFOSAA	<i>N</i> -Methyl-d ₃ -perfluoro-1-octanesulfonamide acetic acid	50.0
3	D ₅ -EtFOSAA	<i>N</i> -Ethyl-d ₅ -perfluoro-1-octanesulfonamide acetic acid	50.0
4	¹⁸ O ₂ -PFHxS	Sodium perfluoro 1-hexane [¹⁸ O ₂]-sulfonate	50.0
5	¹³ C ₄ -PFOS	Sodium perfluoro 1-[1,2,3,4- ¹³ C]-octanesulfonate	50.0
6	¹³ C ₂ -PFHxA	Perfluoro-n-[1,2,3,4,6- ¹³ C ₅] hexanoic acid	50.0
7	¹³ C ₅ -PFHpA	Perfluoro-n-[1,2,3,4,5- ¹³ C]-heptanoic acid	50.0
8	¹³ C ₄ -PFOA	Perfluoro-n-[1,2,3,4- ¹³ C]-octanoic acid	50.0
9	¹³ C ₅ -PFNA	Perfluoro-n-[1,2,3,4,5- ¹³ C]-nonanoic acid	50.0
10	¹³ C ₂ -PFDA	2-Perfluorooctyl [1,2- ¹³ C]-ethanoic acid	50.0
11	¹³ C ₂ -PFUnDA	2-Perfluorooctyl [1,2- ¹³ C]- undecanoic acid	50.0
12	¹³ C ₃ -GenX	2,3,3,3,-Tetrafluoro-2-(1,1,2,2,3,3,3-heptafluoropropoxy)- ¹³ C ₃ -propanoate	50.0

b. Working Solutions

1) **HPLC mobile phase, 20 mM ammonium acetate buffer/acetonitrile (95:5), pH 4.**

To prepare 20 mM ammonium acetate buffer (pH 4.0), dilute 1140 µL of concentrated acetic acid with approximately 800 mL water in a beaker. Adjust pH to 4.0±0.1 by adding drop-wise 1:10 ammonium hydroxide:water mixture. Transfer into a 1 L volumetric flask and fill up to volume with deionized water.

Mix 950 mL of ammonium acetate buffer with 50 mL of acetonitrile in a glass bottle. Prepare as needed and store at room temperature.

2) **HPLC organic mobile phase, 100% HPLC acetonitrile**

Refill as needed and store at room temperature.

3) **Organic solvent for SPE column regeneration, 100% acetonitrile and 100% MeOH**

Refill as needed and store at room temperature.

4) **Solid phase extraction (SPE) 10% MeOH Wash Solution**

100 mL of methanol with water to 1000 mL in a volumetric cylinder. Prepare monthly and store at room temperature

5) Sample Dilution Solution and Solid phase extraction (SPE) Acid Wash Solution, 0.1M formic acid

Dilute 3810 µL of 99% concentrated formic acid with water to 1000 mL in a volumetric cylinder. Prepare monthly and store at room temperature

c. Standards Preparation

1) Calibrators

Selection of analytes to measure branched PFAS (Sb-PFOA and Sm-PFOS)- Perfluoro-5-methylheptanoic acid (P5MHpA) is used to quantitate Sb-PFOA. The PFOA isomers known to be included in Sb-PFOA are perfluoro-3-methylheptanoic acid, perfluoro-4-methylheptanoic acid, perfluoro-5-methylheptanoic acid, perfluoro-6-methylheptanoic acid, perfluoro-4,4-dimethylhexanoic acid, perfluoro-5,5-dimethylhexanoic acid, perfluoro-3,5-dimethylhexanoic acid, and perfluoro-4,5-dimethylhexanoic acid. Similarly, perfluoro-5-methylheptanesulfonate (P5MHpS) is used to quantitate Sm-PFOS. The PFOS isomers known to be included in Sm-PFOS are perfluoro-3-methylheptane sulfonate, perfluoro-4-methylheptane sulfonate, perfluoro-5-methylheptane sulfonate, perfluoro-6-methylheptane sulfonate.

Calibrator spiking solutions (S4-10) are prepared in water/methanol (50/50) for each individual analyte from the commercial native solutions so that a 50-µL of the calibrator spiking solution is spiked into 50 µL serum to provide concentrations that cover the linear range of the method (Table 4). For S1–3 further dilutions of S9 are used to achieve these concentrations. S1–S10 are stored frozen in 1.0 mL aliquots in polypropylene cryogenic vials until use.

Table 4. Typical concentrations (ng/mL) of standards 1–10.

Standard No	n-PFOS	Sb-PFOA (P5MHpA)	All other analytes
S1	0.05	0.1	0.05
S2	0.075	0.15	0.075
S3	0.1	0.2	0.1
S4	0.25	0.5	0.25

S5	0.5	1	0.5
S6	1	2	1
S7	5	10	5
S8	10	20	10
S9	20	40	20
S10	120		75*

*PFHpS, PFHxS, n-PFOA

2) Internal Standard

The internal standard spiking solution is prepared by diluting appropriate amounts of $^{13}\text{C}_2$ -PFHxA, $^{13}\text{C}_5$ -PFHpA, $^{13}\text{C}_4$ -PFOA, $^{18}\text{O}_2$ -FOSA, $^{18}\text{O}_2$ -PFHxS, $^{13}\text{C}_5$ -PFNA, $^{13}\text{C}_2$ -PFDA, $^{13}\text{C}_2$ -PFUnDA, $^{18}\text{O}_2$ -FOSA, D₃-MeFOSAA, D₅-EtFOSAA, $^{13}\text{C}_3$ -GenX (5 ng/mL) and $^{13}\text{C}_4$ -PFOS (10 ng/mL) in water/methanol (50/50), same as previously described with calibrators. A 50 μL spike of this solution provides concentrations of 5 ng/mL for all except PFOS (10 ng/mL) in 50 μL serum. Spiking solutions are stored frozen in 50 mL aliquots in polypropylene cryogenic vials until use.

3) Mass-Spec Operational Check Standard

The instrument test sample is prepared by spiking the reagent blank with all analytes to final concentrations of 0.3-0.5 ng/mL.

4) In-house Proficiency Testing (PT) Samples

Appropriate aliquots of each stock standard are added to calf serum pools to produce 3 sets of in-house proficiency testing (PT) standards. The PT standards are mixed, aliquoted into polypropylene vials and frozen until needed. PT standards are characterized by at least 20 repeated analyses to determine the mean and standard deviation of the measurements.

d. Materials (or those of equivalent performance standards)

- 1) HySphere C8-SE (7 μM) cartridge (i-Chrome solutions, Plainsboro, NJ)
- 2) Chromolith® HighResolution RP-18e column (4.6 \times 100 mm) (Merck KGaA, Germany).
- 3) Chromolith® HighResolution RP-18e Guard column (5 X 4.6 mm) (Merck KGaA, Germany).
- 4) Chromolith® HighResolution RP-18e column (4.6 \times 25 mm) (Merck KGaA, Germany).

- 5) 750 μ L polypropylene autosampler vials with polyethylene snap caps (National Scientific Company, Rockwood, TN).
- 6) Tip ejector variable volume micropipettes (Wheaton, Millville, NJ) and pipette tips (Rainin Instruments Co., Woburn, MA).
- 7) 5.0 mL and 2.0 mL polypropylene cryovials (National Scientific Company, Rockwood, TN).
- 8) HySphere C18 cartridge (i-Chrome solutions, Plainsboro, NJ)
- 9) Assorted glass and polypropylene labware.

e. Equipment (or those of equivalent performance standards)

- 1) Symbiosis extractor equipped with an Alias autosampler and HPLC pump run by the Symbiosis PICO or Pharma software program (Spark Holland Inc. dba iChrom Solutions, Plainsboro, NJ).
- 2) Sciex triple Quad 5500, Sciex triple Quad 6500 +, or Sciex Qtrap 6500 mass spectrometer (Sciex, Foster City, CA).
- 3) TECAN EVO automated sample handling system
- 4) Sartorius Genius Series ME models Electronic Analytical & Semi – microbalances (Sartorius AG, Goettingen, Germany).
- 5) Sartorius top – loading balance (Sartorius AG, Goettingen, Germany).
- 6) pH meter (AB 15 pH Meter, Fisher Scientific).
- 7) Vortex mixer (Type 16700, Barnstead International, Dubuque, Iowa).

f. Instrumentation (or those of equivalent performance standards)

1) Automated SPE

The method uses both left and right cartridge clamps, the four switching valves, and the high-pressure dispenser (Figure 1). The left clamp, the left clamp valve (LCV), and left divert valve (DV-1) are used for SPE separation while the right clamp, the right clamp valve (RCV) and right divert valve (DV-2) are used for the HPLC elution. The SPE run of each sample starts with the conditioning of a HySphere C8-SE (7 μ M) (or HySphere C18) cartridge with HPLC-grade acetonitrile (2 mL) and 0.1 M formic acid (2 mL). Afterward, 500 μ L of the sample (containing 50 μ L serum) injected into the 1 mL sample loop is loaded onto the SPE column using 2 mL 0.1 M formic acid with 1 mL/min flow rate. Next, the SPE column is washed with 2 mL 90% 0.1 M formic acid/10% acetonitrile. The time of the SPE cleanup (including injection time) is 10 min long. Before starting the clean-up of the next sample, the cartridge containing the extracted analytes is transferred by a robotic gripper from the left clamp into the right clamp. Therefore, while the right clamp is used for analyte elution and HPLC-MS/MS acquisition, the left clamp could be used for the clean-up of the next sample. Once the SPE column is in the right clamp, the right clamp valve remains

in by-pass (1-2) position until the HPLC-MS/MS system becomes ready to begin acquisition.

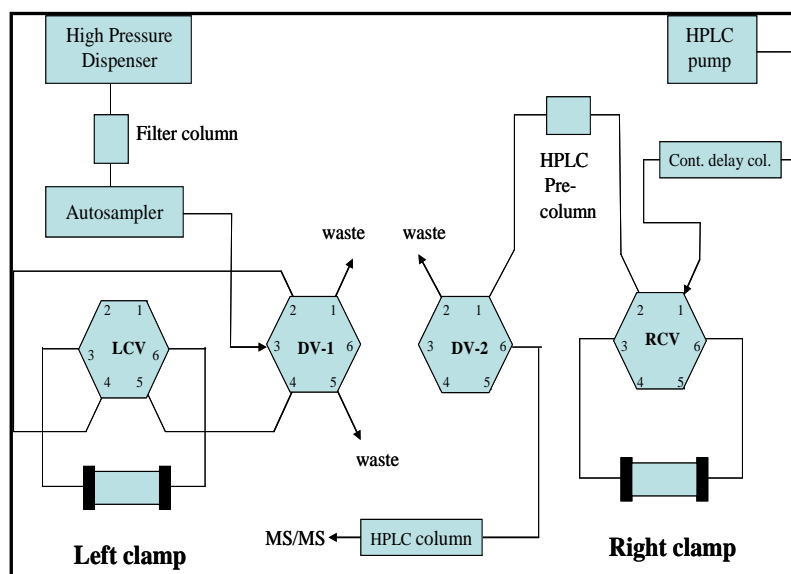

Figure 1. Tubing diagram for the Symbiosis column switching system used in concurrent SPE/HPLC mode. (LCV: left clamp valve; DV-1: divert valve 1; DV-2: divert valve 2; RCV: right clamp valve).

The Symbiosis system or equivalent is used in concurrent SPE/HPLC mode and is controlled by the system specific software.

2) HPLC configuration

At the beginning of the HPLC-MS/MS acquisition, the right clamp valve is turned into 6-1 position for the first 10 min of the HPLC gradient program to transfer the analytes from the SPE column to the HPLC column. At 10 min, the right clamp valve turns back to 1-2 position and the SPE column is returned to the cartridge tray while the HPLC gradient program continues. The HPLC pump is operated at a 1000 $\mu\text{L}/\text{min}$ flow rate with 95% of 20 mM ammonium acetate (pH 4) and 5% of acetonitrile as mobile phase A and 100% acetonitrile as mobile phase B (Table 5). The analytes are separated from each other and other extracted components on two Chromolith® HighResolution RP-18e columns (4.6 \times 100 mm) preceded by a Chromolith® HighResolution RP-18e (5 X4.6 mm) guard column and a Chromolith® HighResolution RP-18e (4.6 \times 25 mm) column or

equivalent. To delay the elution of the PFAS contaminants leaching out from Teflon parts of the HPLC pump, a 4.6 mm x 25 mm Chromolith® HighResolution RP-18e column is inserted between the HPLC pump and the right clamp valve. Because contaminants go through twice the column length, their peaks elute 1 min after the main analytes bands without interfering with the measured concentration.

Table 5. Mobile phase gradient program

Time (min)	0	1	2	7	8	8.01	10	10.01	11	11.01	13	13.01
Mobile phase B%	25	25	45	60	95	95	95	95	95	75	75	75
Flow rate (mL/min)	1.0	1.0	1.0	1.0	1.0	1.0	1.0	1.5	1.5	1.5	1.5	1.0

3) Mass Spectrometer Configuration

Detection of the target analytes is conducted on the Sciex 5500, Sciex 6500+ or Sciex Qtrap 6500 mass spectrometer or equivalent in the negative ion Turbo Ion Spray (TIS) mode. The TIS ionization source is a variant of the electrospray source and is used to convert liquid phase ions into gas phase ions. We use laboratory-grade air heated turbo ion spray gas (GS1=50 and GS2=50) gas. The heated turbo ion spray gas temperature is set at 400 °C. The curtain and collision gas (nitrogen) settings are as follows: collision (medium), curtain gas (CUR=30 [Sciex 5500], CUR=45 [Sciex Qtrap 6500 and Sciex 6500+]). Ionization parameters such as delustering potential (DP) and collision cell energy (CE) parameters are optimized individually for each analyte (Table 6). Unit resolution is used for both Q1 and Q3 quadrupoles. The dwell time is 50 msec for all compounds.

Table 6. Typical mass spectrometer parameters for measuring PFAS. Shaded areas denote a surrogate internal standard with different settings than the native analyte (see bottom of table for details).

Count	Analyte code	Transition	Internal standard code	Transition	DP (V)	CE (eV)
1	FOSA	498/78	¹⁸ O ₂ -FOSA	503/82	-60	-85
2	MeFOSAA	570/512	D ₃ -MeFOSAA	573/515	-45	-30
3	EtFOSAA	584/526	D ₅ -EtFOSAA	589/531	-45	-30
4	PFHxS-1	399/99	¹⁸ O ₂ -PFHxS	403/103	-70	-80
5	PFHpS	449/99	¹³ C ₄ -PFOS ^a	503/99	-35	-60

6	n-PFOS	499/99	¹³ C ₄ -PFOS	503/99	-70	-80
7	Sm-PFOS	499/80	¹³ C ₄ -PFOS	503/80	-70	-90
8	PFHxA	313/269	¹³ C ₂ -PFHxA	315/270	-13	-25
9	PFHpA	363/319	¹³ C ₅ -PFHpA	368/323	-25	-13
10	n-PFOA	413/369	¹³ C ₄ -PFOA ^b	417/372	-27	-14
11	Sb-PFOA	413/369	¹³ C ₄ -PFOA ^b	417/372	-27	-14
12	PFNA	463/419	¹³ C ₅ -PFNA	468/423	-30	-13
13	PFDA	513/469	¹³ C ₂ -PFDA	515/470	30	-15
14	PFUnDA	563/519	¹³ C ₂ -PFUnDA	565/520	-30	-17
15	GenX	329/285	¹³ C ₃ -GenX	332/287	-9	-5
16	ADONA	377/251	¹³ C ₂ -PFHxA ^c	315/270	-20	-10
17	9CI-PF	531/351	¹³ C ₄ -PFOS	503/99	-40	-25

^a ¹³C₄-PFOS DP (V) and CE (eV) is -70 and -80, of respectively. ^b ¹³C₄-PFOA DP (V) and CE (eV) is -30 and -15, respectively. ^c ¹³C₂-PFHxA DP (V) and CE (eV) -13 and -25, respectively.

g. Replacement and periodic maintenance of key components

(1) Sciex 5500, Sciex 6500+, or Sciex 6500 Qtrap Mass Spectrometer

Preventative maintenance is done by a qualified engineer at least once a year. In addition, to ensure proper performance of the system, a periodic maintenance of the system may be required.

- (a) When a partial blockage of the vacuum is suspected, the orifice is probed with a syringe-cleaning wire.
- (b) Cleaning of the spray shield and the entrance end of the heated capillary is performed weekly as described in the Sciex 5500, Sciex 6500+, or Sciex 6500 Qtrap Hardware Manual. First, wash with a solution of water: methanol (1:1) and then, with 100% methanol. Wipe the area using flake free paper wipes.
- (c) The pump oil is changed approximately every six months as part of the periodic maintenance of the system.

(2) Symbiosis system

Preventative maintenance is done by a qualified engineer at least once a year. Additional maintenance may be necessary if there is

a general decrease in instrument performance (see below). In general, performance maintenance procedures are performed after detecting a decrease in the system performance (sensitivity and/or S/N ratio) without any other apparent technical reasons.

- (a) The HPLC column is replaced when analyte resolution decreases. Once the analyte peaks start tailing, the HPLC column should be replaced.
- (b) If high pressure (>250 bar) error messages are observed, the purge valve frit, the guard column, analytical column frit, HPLC lines, needle seat, or injector components may need to be replaced. See also section 8b.
- (c) Reestablishment of performance and calibration. Every time the system is disturbed for cleaning or maintenance, a mass spec operational check standard is analyzed to assess the HPLC and MS performance. For the mass spectrometer, a retune of the system may or may not be necessary. If the instrument does not pass this test, then the instrument is retuned using PPG as described previously.

Preventative maintenance is done by a qualified engineer at least once a year. Additional maintenance may be necessary if there is a general decrease in instrument performance.

If the Symbiosis error “HPD 1 high pressure problem” occurs, check the SPE lines and HPD 6 port valve. The HPD valve stator and/or rotor may need to be replaced.

The instrumentation used is serviced according to the manufacturer’s guidance included in the instrument manuals or based on the recommendation of experienced analysts/operators after following appropriate procedures to determine that the instrument performs adequately for the intended purposes of the method.

7. Calibration and Calibration-Verification Procedures

a. Calibration Curve

Ten-point calibration curves are normally constructed with each quantitative run from the analyte area ratios (i.e., analyte area/internal standard area) obtained from extracted standards in calf serum. A linear regression analysis (weighted by 1/x) of the area ratio versus standard concentration is performed. Correlation coefficients are generally greater than 0.98. Samples with values exceeding the

highest point in the calibration curve are reanalyzed using less serum as described in Section 11.

b. Mass Spectrometer Calibration

The Sciex 5500, Sciex 6500+, or Sciex 6500 Qtrap mass spectrometer or equivalent is calibrated and tuned at least once per year using a polypropylene glycol (PPG) solution according to the instructions contained in the operator's manual. The instrument sensitivity is checked periodically by injecting the Instrument Test sample.

c. Calibration Verification

- 1) Calibration accuracy is tested with each run by analysis of blank and quality control samples. A full set of calibrators (1—10) is analyzed with each batch of samples. Additional verification is provided by periodic external and internal proficiency testing.
- 2) Calibration verification is not required by the manufacturer. However, it should be performed after any substantive changes in the method or instrumentation (e.g., new internal standard, change in instrumentation), which may lead to changes in instrument response, have occurred.
- 3) Calibration verification must be performed at least once every 6 months.
- 4) All calibration verification runs and results shall be appropriately documented.
- 5) According to the updated CLIA regulations from 2003 (<http://www.cms.gov/Regulations-and-Guidance/Legislation/CLIA/downloads/6065bk.pdf>), the requirement for calibration verification is met if the test system's calibration procedure includes three or more levels of calibration material, and includes a low, mid, and high value, and is performed at least once every six months. All samples used for verification must be of known concentration.
- 6) The conditions above are met with the calibration procedures for this method. Therefore, no additional calibration verification is required by CLIA.

d. Proficiency Testing (PT)

- 1) PT should be performed a minimum of once per 6 months. When PT is required, the laboratory supervisor or his/her designee will notify the PT administrator, and the PT administrator will randomly select five PT materials for analysis. Following analysis, the results will be forwarded directly to the PT administrator for evaluation. A passing score is obtained if at least four of the five samples fall within the prescribed limits established by the PT administrator. The PT administrator will notify the laboratory supervisor and/or his/her designee of the PT results (i.e., pass/fail). All proficiency results shall be appropriately documented.
- 2) For this method Internal PT is completed two times a year. Three pools of PT samples, encompassing the linear range of the method, are prepared in-house as described in the standard preparation section. Characterization of PT materials requires at least 20 separate determinations. Once the PT pools are characterized, the mean concentration and standard deviation of the PT materials are forwarded to a DLS representative (PT administrator) responsible for executing the PT program. These PT samples are blind coded by the PT administrator and returned to the laboratory staff for storage.
- 3) When available, the laboratory participates in external PT programs such as the ongoing Arctic Monitoring and Assessment Program (AMAP) Ring Test for several PFAS in human serum, conducted by the Institut National de Santé Publique du Québec (INSPQ) in Canada.

8. Operating Procedures; Calculations; Interpretation of Results

a. Sample preparation

- 1) An analytical run consists of unknown serum samples, QCs, serum blanks (SB), reagent blanks (RB), and standards (S1–S10)
- 2) Remove serum samples, S1–S10, and internal standard solution from the freezer, and let them thaw to room temperature. Label polypropylene snap-cap autosampler vials with appropriate sample names. Aliquot 0.1 M formic acid 450 μ L into all vials.
- 3) Dispense 50 μ L of internal standard solution into each polypropylene autosampler snap cap vials.
- 4) Add 50 μ L of the appropriate S1–S10 solution into the polypropylene vials designated for standards.

- 5) Aliquot 50 μL of unknown serum samples, QCs, and SBs into the designated autosampler vials. For S1–S10, aliquot 50 μL of calf serum. When an unknown serum sample volume is limited or collected from highly exposed populations with PFAS concentrations much higher than concentrations resulting from general background exposures (e.g., occupational settings, contamination sites), analysis may be conducted with a smaller amount of serum. In these circumstances, the volume used must be noted appropriately throughout the analytical procedure. Further description can be found in below in Reportable Range.
- 6) Cap and vortex all vials for at least 10 seconds to make sure all the internal standard and standard mixed into the sample.

Alternatively, automatic sample preparation can be completed following this approach using the TECAN EVO liquid handling system.

b. Automated SPE-HPLC-MS/MS Analysis Procedure

- 1) Initialize the Alias autosampler, the high-pressure dispenser (HPD) and the automated cartridge exchanger (ACE) unit. Flush the Alias autosampler needle.
- 2) Exchange the cartridge tray after every 700 samples.
- 3) Purge the solvent lines on the HPLC binary pump and equilibrate the HPLC column, verifying the absence of leaks or obstructions in mobile phase flow path.

9. Analysis

a. Check the LC/MS interface

- 1) If the instrument is in ready mode, wait until the interface cools down. When the interface is cool enough, take out the capillary from the MS interface. Rinse the capillary with MeOH, sonicate in MeOH for 20 min if necessary. Periodically, take off the interface housing, and wipe out the skimmer plate.
- 2) Open the rough pump cabinet, check for oil leaks and unusual noise. Report anything unusual.

b. Check the LC system

After the column has been conditioned, used the current method and let the system equilibrate for approximately 30 minutes. Run the Instrument Check sample by opening the batch file named Instrument_test.dab. Change the date in the Sample Name field. Make sure the proper Acquisition Method and Vial Position are entered and submit the batch. The file should be saved into the Instrument_test.wiff file. Open the chromatogram and compare the intensities and peak shape to those obtained a day and a week before. If peaks appear distorted (tailing peaks, broad peaks, etc.) change the column and submit the Instrument Check sample again. If the absolute intensity is too low (peak intensity should not be <70% less intense than before) check with the laboratory supervisor or his/her designee.

c. Building batch files

- 1) In the Analyst software, open a new subproject folder for each new run. The subproject should have the same YYYY-MMDD name as the unknowns it includes. Each subproject should have separate Acquisition Methods, Quantitation Methods, Batch, Data, and Results directories. Copy the latest Acquisition Method and Quantitation Method from the previous subfolder.
- 2) From Excel, open the sample sequence and save as a text file in the same format as the subproject. Open the Analyst software, create a new batch table, and import the YYYY-MMDD.txt file.
- 3) Make sure that the proper Acquisition Method and Quantitation Method are entered. Although the vial positions entered in Analyst will not be used, they should agree with the vial positions used on the Alias autosampler.

d. Starting the SPE-HPLC-MS/MS run

Submit the batch table in Analyst (highlight and/or click Submit, go to View Queue, and click Start Sample). From this on everything should run automatically.

10. Data Processing

a. Peak Integration and Quantification

Each peak is visually inspected and peak integration is corrected if the MultiQuant software erroneously integrates a peak.

b. Excluding Calibrators

Anomalous calibrators that are not linear with the rest of the calibration curve may be excluded when the following conditions are met

- 1) The calibration curve must have at least five calibrators
- 2) The QC are within the reportable range (as defined by the target concentration from the lowest to the highest calibrator)
- 3) Samples that are no longer in the reportable range are not reported
- 4) The cause of the anomaly is identified. For example, no or low addition of native analyte or internal standard or missed injection due to instrument failure

c. Excluding Samples

Sample data may be excluded if the absolute IS response is identified as being too high or too low (using limits identified as typical for each analyte). Mis-injection, poor chromatography, or interfering co-eluent may also be used as criteria for sample rejection and repeat analysis.

d. Importing Data into the Database

Results are exported as a .txt file using the MultiQuant software. The tab-delimited file is uploaded into the database.

11. Method Performance

a. Reportable Range

The linear range of the standard calibration curves and the method limit of detection (LOD) determine the reportable range of results. The reportable range must be within the range of the calibration curves. However, samples with concentrations exceeding the highest reportable limit may be diluted, re-extracted, and reanalyzed so that the measured value will be within the range of the calibration.

For dilutions up to 5x the original concentration, less than 50 uL of serum but no less than 10 uL is used. The remaining volume is brought up to 50 uL using 0.1 formic acid solution and the sample is analyzed as previously described. If larger dilutions are required, up to 50x the original concentration, no less than 10 uL of serum can be diluted with up to 0.5 mL of blank calf serum in a 2 ml vial. 50 uL of the diluted sample removed and analyzed as previously described. If more than 50x dilution is needed a 2-step process can be considered but limited to two serial dilution steps with blank calf serum and no less than 10uL volume transfer. When dilutions are made,

appropriate adjustments to the final concentrations are made to reflect the dilution steps used. Dilutions schemes have been previously described.³²

b. Analytical Sensitivity

The limits of detection (LOD) for each analyte are listed in Table 7.

c. Analytical Specificity

This is a highly selective method that requires that the PFAS 1) elute at a specific retention time; 2) have precursor ions with specific mass/charge ratios; 3) have specific product ions formed from the precursor ion with specific mass/charge ratios.

d. Linearity Limits

The calibration curve is linear for all analytes (generally $R^2 > 0.98$). The limit on the linearity is determined by the highest standard analyzed in the method. Because of the wide variation of PFAS concentrations in humans, we set our highest standard near the high end of the linear range (Table 7). Study samples whose concentrations exceed the highest standard concentration must be re-extracted using a smaller aliquot. The low end of the linear range is limited by the method LOD. Concentrations below the method LOD (or the concentration of the lowest standard in the calibration curve) are reported as less than LOD.

Table 7. Linear range (lowest – highest standard concentration) and LOD for each PFAS measured in serum.

Analyte	LOD (ng/mL)	Range (ng/mL)*
FOSA	0.1	0.05–20
MeFOSAA	0.1	0.05–20
EtFOSAA	0.1	0.05–20
PFHxS	0.1	0.05–75
PFHpS	0.1	0.05–75
n-PFOS	0.1	0.05–120
Sm-PFOS	0.1	0.05–65
PFHxA	0.1	0.05–20
PFHpA	0.1	0.05–20
n-PFOA	0.1	0.05–75
Sb-PFOA	0.1	0.05–40
PFNA	0.1	0.05–20

PFDA	0.1	0.05–20
PFUnDA	0.1	0.05–20
GenX	0.1	0.05–20
ADONA	0.1	0.05–20
9CI-PF	0.1	0.05–20

*The upper concentration range may be extended by including additional standards or performing additional dilutions.

e. Accuracy

The accuracy of the method is determined by enriching serum samples with known concentrations of PFAS and comparing the calculated and expected concentrations. To examine their consistency over the range of levels encountered in serum, the measurements are taken at 3 different concentrations, namely using standards near 3*LOD, middle level (~2.5 ng/mL), and high level (~10.0 ng/mL). The accuracy is calculated from 5 day's independent measurements and recovery should be 85-115% except at 3*LOD where can be 80-120%.

f. Precision

The precision of this method is reflected in the variance of two quality control (QC) pools over a period of 10 days. The coefficient of variation (CV) of repeated measurements of these QC pools, which reflects both inter and intra-day variations, is used to estimate precision. Total relative standard deviations were $\leq 15\%$ ($CV \leq 15\%$).

12. Quality Control (QC) Procedures

a. Evaluating Sample QC

Sample QC rules are applied to individual samples (i.e., standards, unknown samples, serum blanks, and QC samples).

- 1) For each analyte, the relative retention time (RT) (ratio of RT_{analyte} and RT_{IS}) of standards, unknowns, and QCs should be checked. If the relative RT falls outside the range, check the integration to make sure the analyte or IS peak was properly identified.
- 2) For each analyte, the IS area counts should meet minimum area count requirements. Low IS area counts suggest strong ion suppression from the matrix, error during the addition of IS to the

sample, or mis-injection of the sample onto the instrument. Depending on the findings, either re-extract the sample as usual or re-extract the sample after dilution.

For each analyte, the average of the absolute value of the calculated concentration of three SB should be less the LOD for each analyte. Using the current method, all standards, blanks and unknown samples are prepared following the same procedure, thus background blank values (reflected in the intercept of the calibration curve) are automatically subtracted from the concentrations of unknown samples. If background levels are above the LOD, the reagents used for sample preparation and (or) mobile phases need to be checked for potential contamination.

For each analyte, if the concentration in an unknown sample is above the highest calibration standard, the sample needs to be re-extracted with a smaller volume of serum as previously described in Section 11.

b. Run QC materials

1) Preparing Run QC Pools

QC materials are prepared in bulk from calf serum (Gibco, Grand Island, NY). The target ranges for the pools are set to encompass the expected concentration ranges in human populations. serum is pooled and mixed uniformly, divided into two subpools and stored frozen. The subpools are enriched with PFAS as needed to afford low concentration (QCL) and high concentration (QCH) subpools. Consult the DLS Policy and Procedure Manual (PPM) to determine appropriate QCL and QCH concentrations.³³

2) Establishing Run QC limits

Quality control limits are established by 20 separate analyses of each QC pool (QCL and QCH). Different analysts, columns, and instruments, etc. should be used during characterization to capture realistic assay variation during routine use. Each instrument can characterize no more than two samples from one pool per day. The mean, standard deviation, coefficient of variation, and confidence limits are calculated from this QC characterization data set using a SAS program provided by DLS. Control charts and metrics from the characterization runs are examined for trends and suitability for the assay (such as acceptable precision, i.e., $CV < \%15$). Once established, these controls limits are used to evaluate results from the routine analysis of the QCs in analytical batches.

3) Evaluating Run QC

Standard criteria for run rejection based on statistical probabilities are used to declare a run either in-control or out-of-control³⁴.

QC rules for: Analytical run with 1 QC pool per run (must also include a blank QC specimen):

One QC pool per run with one QC result per pool

- 1) If QC run result is within $2S_i$ limits, then accept the run.
- 2) If QC run result is outside a $2S_i$ limit - reject run if:
 - a) Extreme Outlier – Run result is beyond the characterization mean $\pm 4S_i$
 - b) 1 3S Rule - Run result is outside a $3S_i$ limit
 - c) 2 2S Rule - Current and previous run results are outside the same $2S_i$ limit
 - d) 10 X-bar Rule – Current and previous 9 run results are on same side of the characterization mean
 - e) R 4S Rule – The current and the previous run results differ by more than $4S_i$. Note: Since runs have a single result per pool and only 1 pool, the R 4S rule is applied across runs only.

One QC pool per run with two or more QC results per pool

- 1) If QC run mean is within $2S_m$ limits and individual results are within $2S_i$ limits, then accept the run.
- 2) If QC run mean is outside a $2S_m$ limit - reject run if:
 - a) Extreme Outlier – Run mean is beyond the characterization mean $\pm 4S_m$
 - b) 3S Rule - Run mean is outside a $3S_m$ limit
 - c) 2 2S Rule – Current and previous run means are outside the same $2S_m$ limit
 - d) 10 X-bar Rule – Current and previous 9 run means are on same side of the characterization mean
- 3) If one of the two QC individual results is outside a $2S_i$ limit - reject run if:
 - a) R 4S Rule – Within-run range for the current run and the previous run exceeds $4S_w$ (i.e., 95% range limit)

Abbreviations:

S_i = Standard deviation of individual results (the limits are not shown on the chart unless run results are actually single measurements).

S_m = Standard deviation of the run means (the limits are shown on the chart).

S_w = Within-run standard deviation (the limits are not shown on the chart).

QC rules for: Analytical run with 2 QC pools per run:

Two QC pools per run with one QC result per pool

- 1) If both QC run results are within $2S_i$ limits, then accept the run.
- 2) If 1 of the 2 QC run results is outside a $2S_i$ limit - reject run if:
 - a) Extreme Outlier – Run result is beyond the characterization mean $\pm 4S_i$
 - b) 3S Rule - Run result is outside a $3S_i$ limit
 - c) 2S Rule - Both run results are outside the same $2S_i$ limit
 - d) 10 X-bar Rule – Current and previous 9 run results are on same side of the characterization mean
 - e) R 4S Rule – Two consecutive standardized run results differ by more than $4S_i$. Note: Since runs have a single result per pool for 2 pools, comparison of results for the R 4S rule will be with the previous result within run or the last result of the previous run. Standardized results are used because different pools have different means.

Two QC pools per run with two or more QC results per pool

- 1) If both QC run means are within $2S_m$ limits and individual results are within $2S_i$ limits, then accept the run.
- 2) If 1 of the 2 QC run means is outside a $2S_m$ limit - reject run if:
 - a) Extreme Outlier – Run mean is beyond the characterization mean $\pm 4S_m$
 - b) 3S Rule - Run mean is outside a $3S_m$ limit
 - c) 2S Rule - Both run means are outside the same $2S_m$ limit
 - d) 10 X-bar Rule – Current and previous 9 run means are on same side of the characterization mean
- 3) If one of the 4 QC individual results is outside a $2S_i$ limit - reject run if:
 - a) R 4S Rule – Within-run ranges for all pools in the same run exceed $4S_w$ (i.e., 95% range limit). Note: Since runs have multiple results per pool for 2 pools, the R 4S rule is applied within runs only.

QC rules for: Analytical run with 3 QC pools per run:

Three QC pools per run with one QC result per pool

- 1) If all 3 QC run results are within 2Si limits, then accept the run.
- 2) If 1 of the 3 QC run results is outside a 2Si limit - reject run if:
 - a) Extreme Outlier – Run result is beyond the characterization mean +/- 4Si
 - b) 3S Rule - Run result is outside a 3Si limit
 - c) 2S Rule - 2 or more of the 3 run results are outside the same 2Si limit
 - d) 10 X-bar Rule – Current and previous 9 run results are on same side of the characterization mean
 - e) R 4S Rule – Two consecutive standardized run results differ by more than 4Si. Note: Since runs have a single result per pool for 3 pools, comparison of results for the R 4S rule will be with the previous result within the current run or with the last result of the previous run. Standardized results are used because different pools have different means.

Three QC pools per run with two or more QC results per pool

- 1) If all 3 QC run means are within 2Sm limits and individual results are within 2Si limits, then accept the run.
- 2) If 1 of the 3 QC run means is outside a 2Sm limit - reject run if:
 - a) Extreme Outlier – Run mean is beyond the characterization mean +/- 4Sm
 - b) 3S Rule - Run mean is outside a 3Sm limit
 - c) 2S Rule - 2 or more of the 3 run means are outside the same 2Sm limit
 - d) 10 X-bar Rule – Current and previous 9 run means are on same side of the characterization mean
- 3) If one of the QC individual results is outside a 2Si limit - reject run if:
 - a) R 4S Rule - 2 or more of the within-run ranges in the same run exceed 4Sw (i.e., 95% range limit). Note: Since runs have multiple results per pool for 3 pools, the R 4S rule is applied within runs only.

13. Remedial Action if Calibration or QC Systems Fail to Meet Acceptable Criteria

If the QC systems or the calibrations failed to meet acceptable criteria, operations are suspended until the source or cause of failure is identified and

corrected. If the source of failure is easily identifiable (e.g., failure of the mass spectrometer or a pipetting error), the problem is immediately corrected. Otherwise, fresh reagents are prepared and the mass spectrometer is cleaned. Before beginning another analytical run, several QC materials (in the case of QC failure) or calibration standards (in the case of calibration failure) are reanalyzed. After calibration or quality control has been reestablished, analytical runs may be resumed.

14. Limitations of Method; Interfering Substances and Conditions

Occasionally, the concentration of the PFAS in serum may be higher than the highest standard in the calibration curves, and 0.1 mL of sample may be too much to use. This is evident by the low recovery of the isotope-labeled standard after the SPE extraction. In this case, a smaller aliquot of serum can be used.

15. Reference Ranges (Normal Values)

Results (<http://www.cdc.gov/exposurereport>) from the National Health and Nutrition Examination Survey (NHANES) can be used as reference ranges for the general US population³⁵.

16. Critical-Call Results (“Panic” Values)

Critical call values have not been established for any PFAS concentrations.

17. Specimen Storage and Handling During Testing

Specimens are stored in the laboratory frozen prior to analysis. Frozen samples are thawed completely at room temperature or in a 25 °C sonicating water bath prior to the initiation of the analytical procedure.

18. Alternate Methods for Performing Test and Storing Specimens if Test System Fails

Alternate procedures do not exist in-house for the measurement of PFAS. If the analytical system fails, storage of prepared samples refrigerated is recommended until the system is operational again. Please see Appendix A for further information on sample stability.

19. Test-Result Reporting System; Protocol for Reporting Critical Calls (If Applicable)

Once the validity of the data is established by the QC/QA system outlined above. The QA/QC officer initiates result reporting in STARLIMS. Results are first verified by a DLS statistician, who approves the QC and produces an electronically generated QC report. The file containing the sample results, QC

report, and a cover letter will then be routed through the appropriate channels for approval (i.e. supervisor, branch chief, division director). After approval at the division level, the report is sent to the study or project point of contact.

20. Transfer or Referral of Specimens; Procedures for Specimen Accountability and Tracking

Standard record keeping systems (e.g., notebooks, sample logs, data files) should be employed to keep track of all specimens. One spreadsheet form with information for receiving/transferring specimens is kept in the laboratory. In this form, the samples received are logged in when received and when stored/transferred after analysis. For NHANES samples, the person receiving the specimens signs and dates the shipping manifests. The shipping manifests for NHANES and other samples are kept in a binder in the Laboratory.

Use of trade names is for identification only and does not imply endorsement by the Public Health Service or the U.S. Department of Health and Human Services.

21. Summary Statistics and QC Graphs

See next pages.

Summary Statistics and QC Chart for 2-(N-methyl-PFOSA)acetic acid (ng/mL)

Lot	N	Start Date	End Date	Mean	Standard Deviation	Coefficient of Variation
HQC-012019	35	26FEB19	08OCT19	4.0930	0.3097	7.6
LQC-012019	35	26FEB19	08OCT19	1.1230	0.0849	7.6

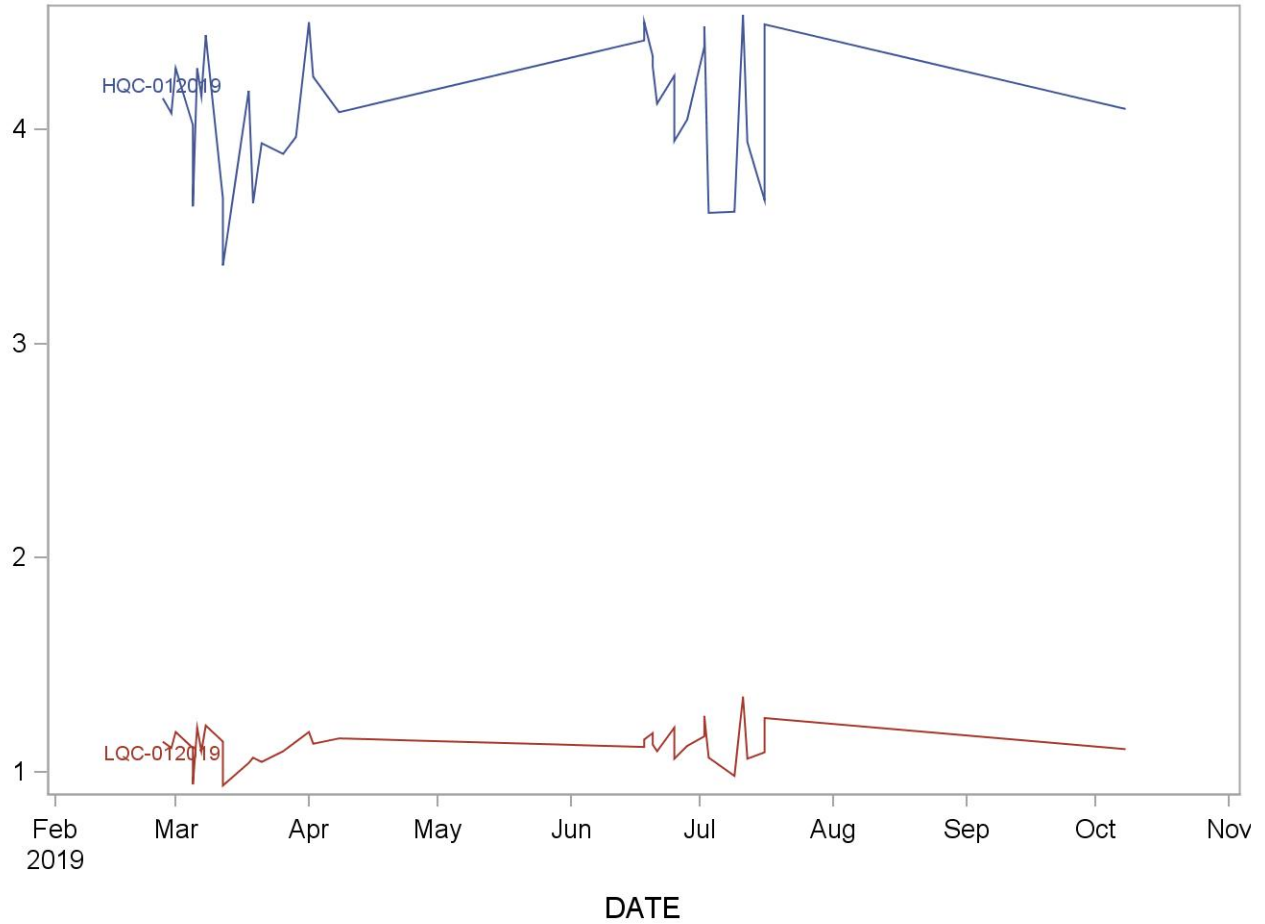

Summary Statistics and QC Chart for Br. perfluorooctanoic acid iso (ng/mL)

Lot	N	Start Date	End Date	Mean	Standard Deviation	Coefficient of Variation
HQC-012019	35	26FEB19	08OCT19	6.2337	0.6187	9.9
LQC-012019	35	26FEB19	08OCT19	2.0220	0.2762	13.7

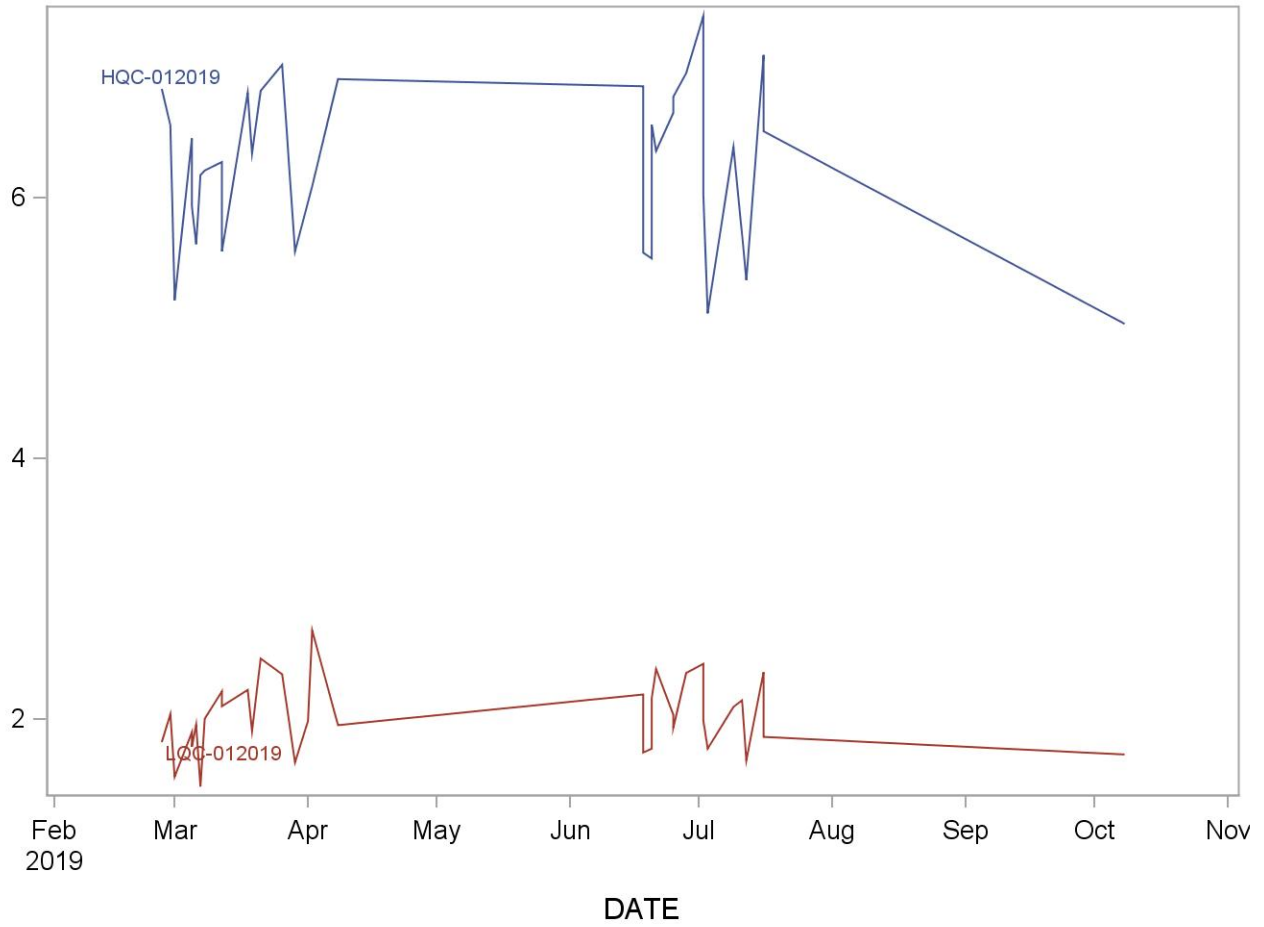

Summary Statistics and QC Chart for Perfluorodecanoic acid (ng/mL)

Lot	N	Start Date	End Date	Mean	Standard Deviation	Coefficient of Variation
HQC-012019	35	26FEB19	08OCT19	3.9984	0.3356	8.4
LQC-012019	35	26FEB19	08OCT19	1.2700	0.1302	10.3

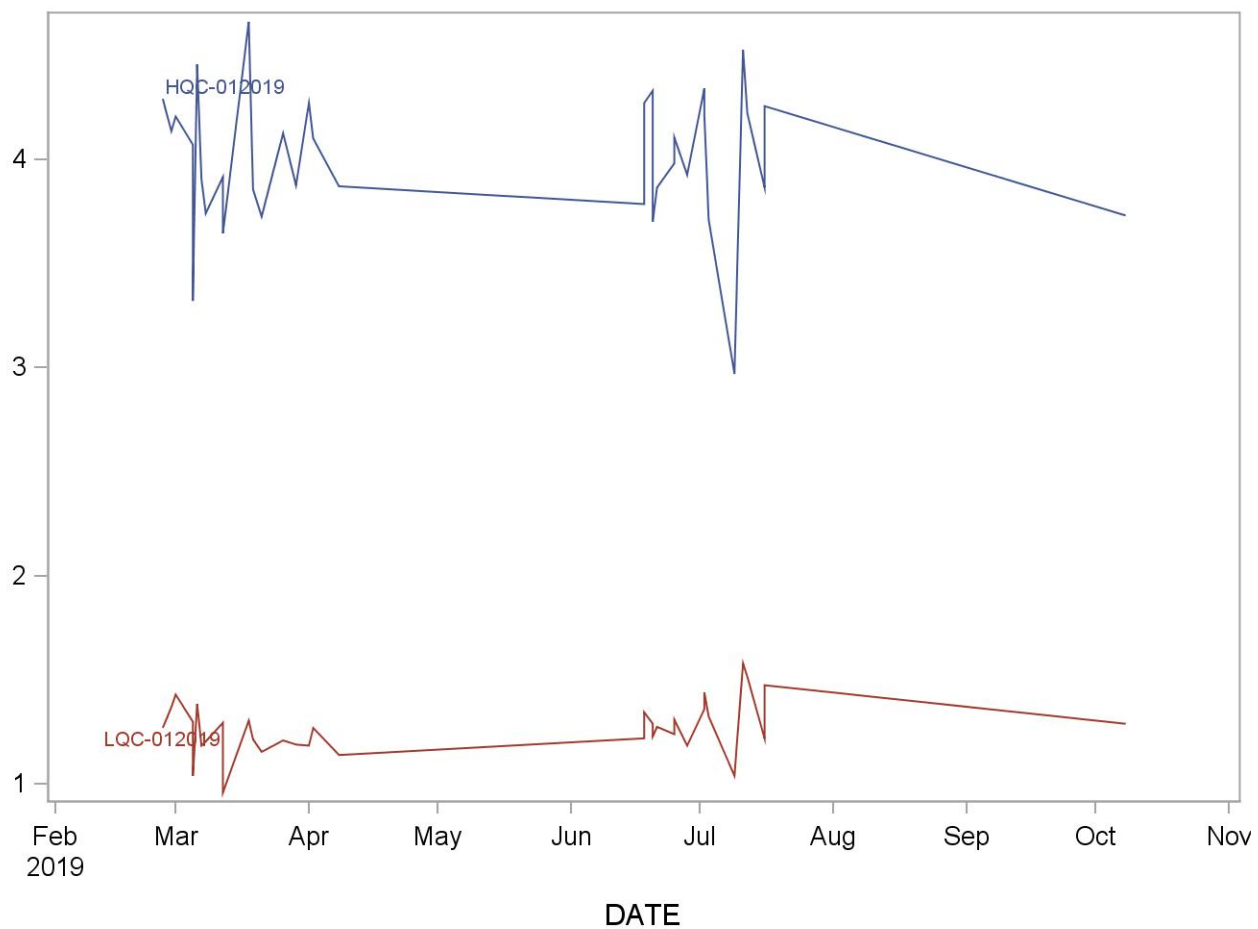

Summary Statistics and QC Chart for Perfluorohexane sulfonic acid (ng/mL)

Lot	N	Start Date	End Date	Mean	Standard Deviation	Coefficient of Variation
HQC-012019	35	26FEB19	08OCT19	4.8914	0.3898	8.0
LQC-012019	35	26FEB19	08OCT19	2.1339	0.1483	7.0

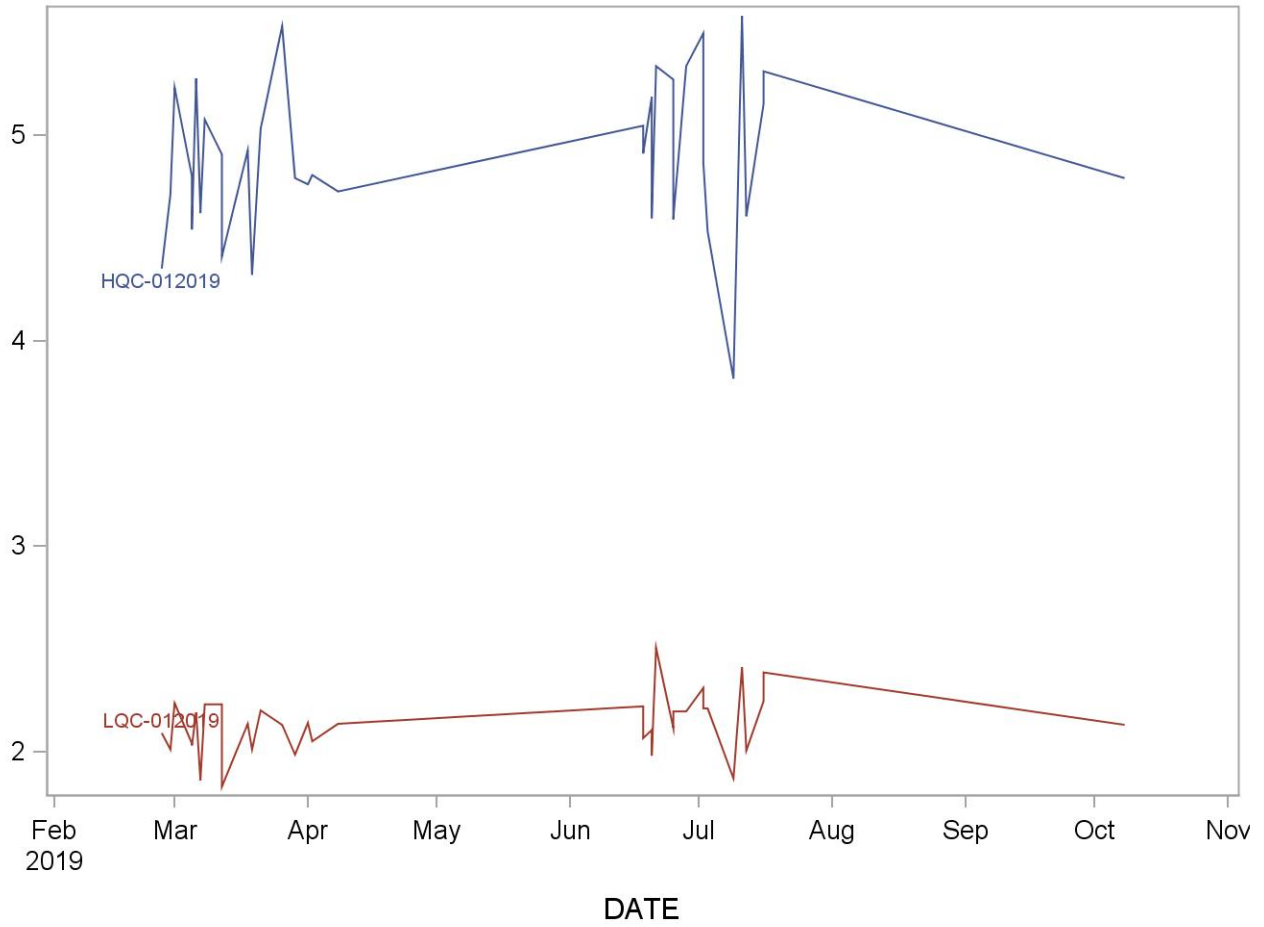

Summary Statistics and QC Chart for Perfluorononanoic acid (ng/mL)

Lot	N	Start Date	End Date	Mean	Standard Deviation	Coefficient of Variation
HQC-012019	35	26FEB19	08OCT19	4.5720	0.3739	8.2
LQC-012019	35	26FEB19	08OCT19	1.8527	0.1910	10.3

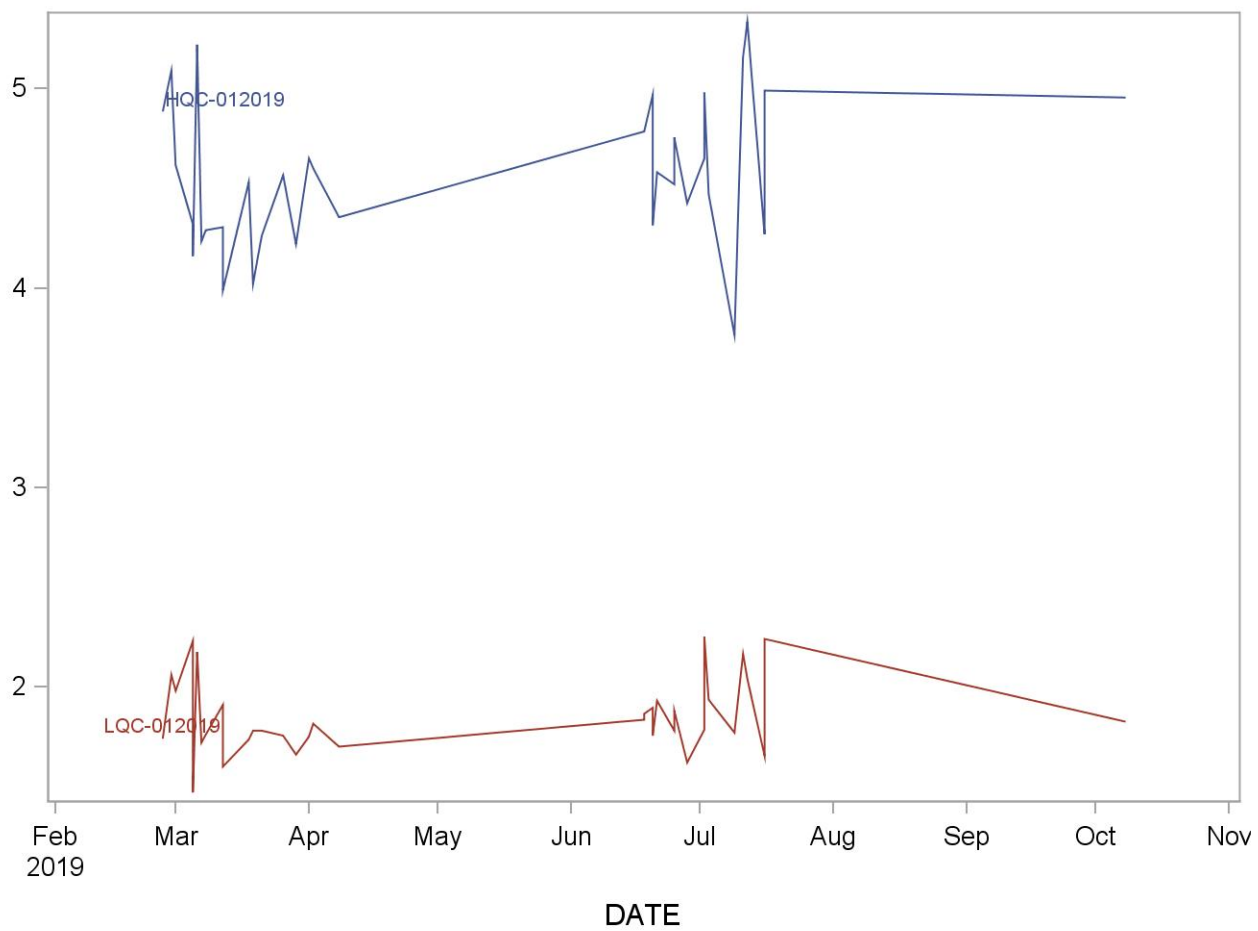

Summary Statistics and QC Chart for Perfluoroundecanoic acid (ng/mL)

Lot	N	Start Date	End Date	Mean	Standard Deviation	Coefficient of Variation
HQC-012019	35	26FEB19	08OCT19	4.4157	0.3905	8.8
LQC-012019	35	26FEB19	08OCT19	1.3729	0.1185	8.6

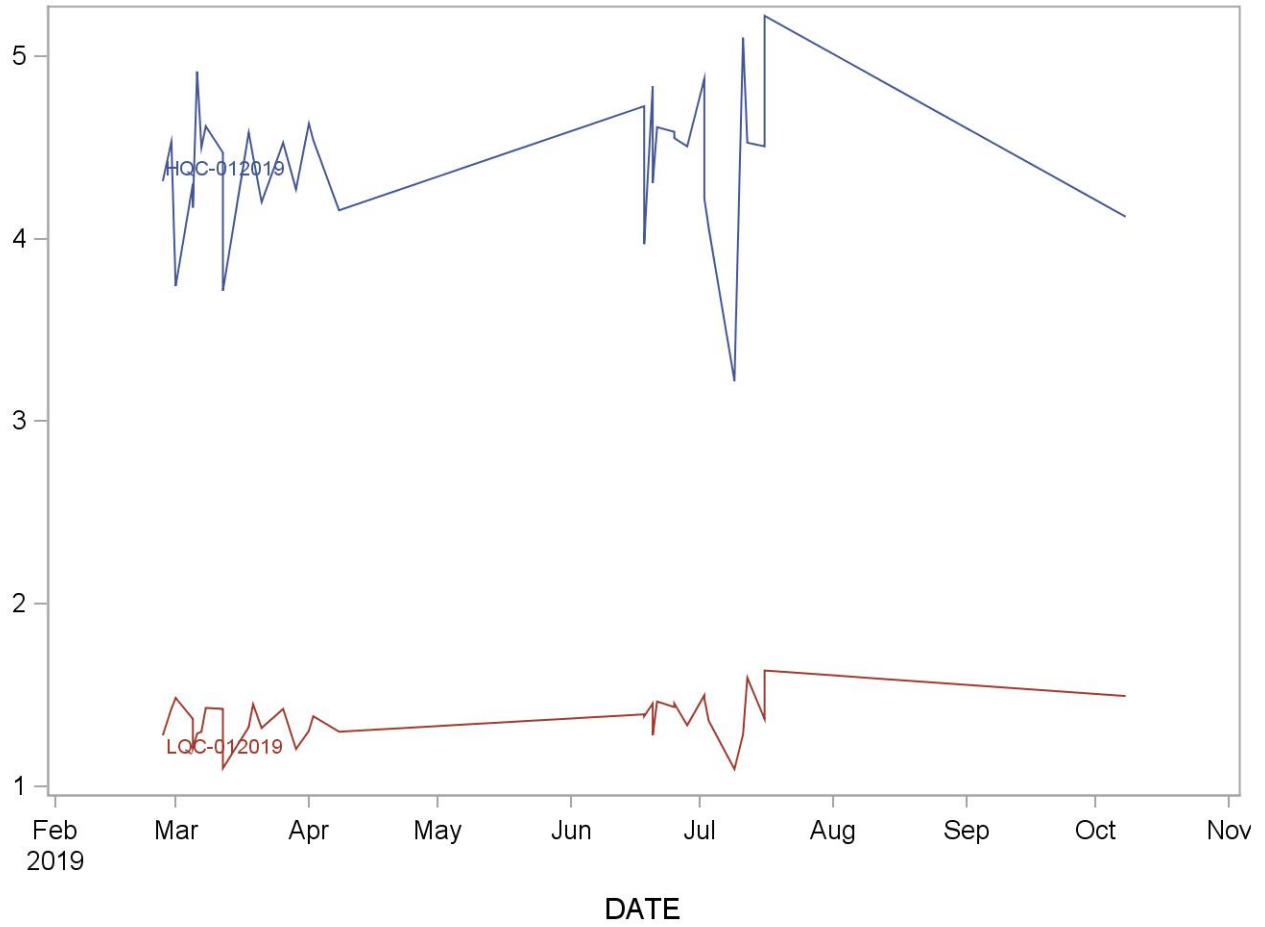

Summary Statistics and QC Chart for Sm-PFOS (ng/mL)

Lot	N	Start Date	End Date	Mean	Standard Deviation	Coefficient of Variation
HQC-012019	35	26FEB19	08OCT19	1.8830	0.1901	10.1
LQC-012019	35	26FEB19	08OCT19	0.7410	0.1047	14.1

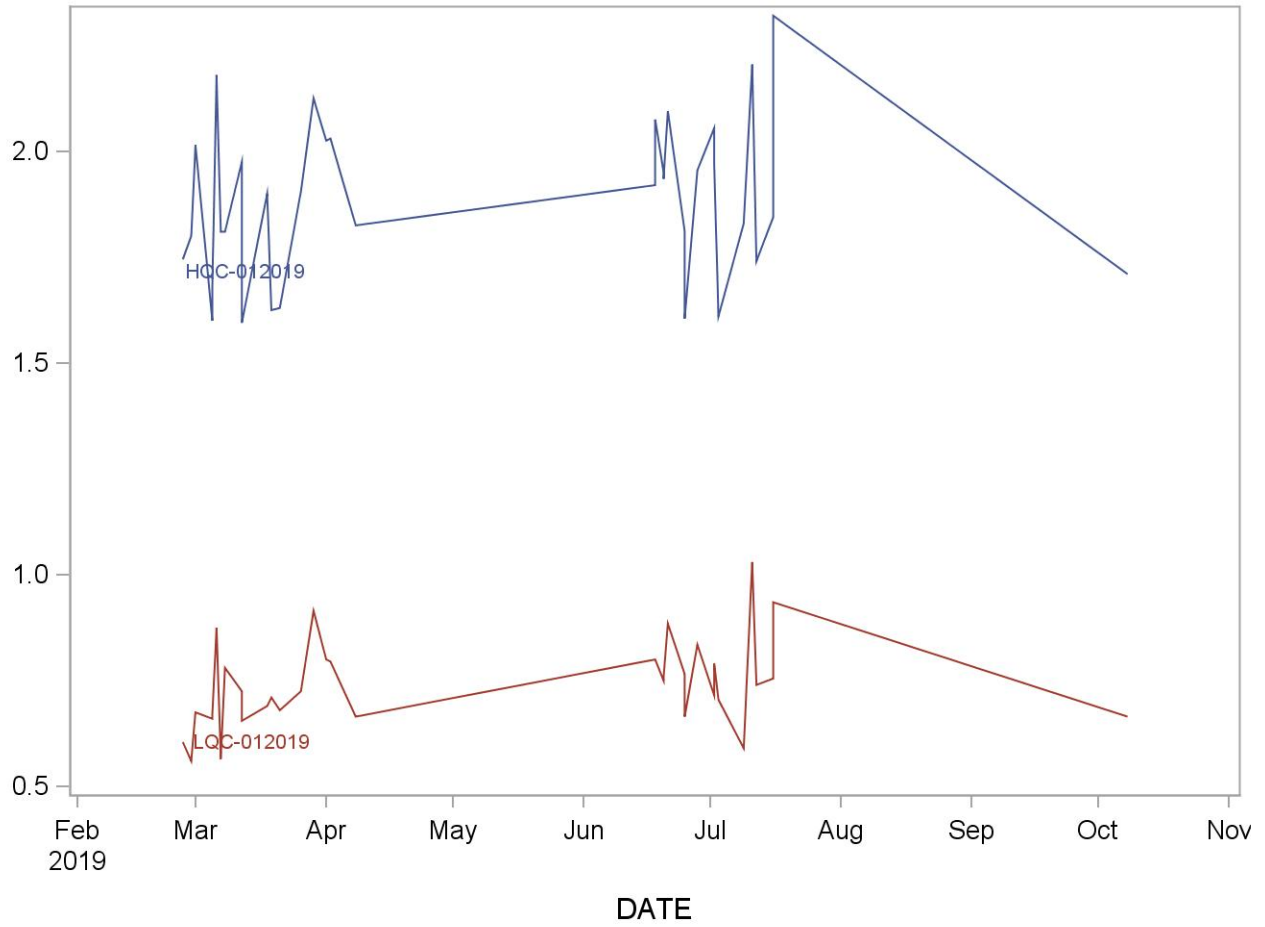

Summary Statistics and QC Chart for n-perfluorooctane sulfonic acid (ng/mL)

Lot	N	Start Date	End Date	Mean	Standard Deviation	Coefficient of Variation
HQC-012019	35	26FEB19	08OCT19	7.2150	0.6123	8.5
LQC-012019	35	26FEB19	08OCT19	3.9207	0.3119	8.0

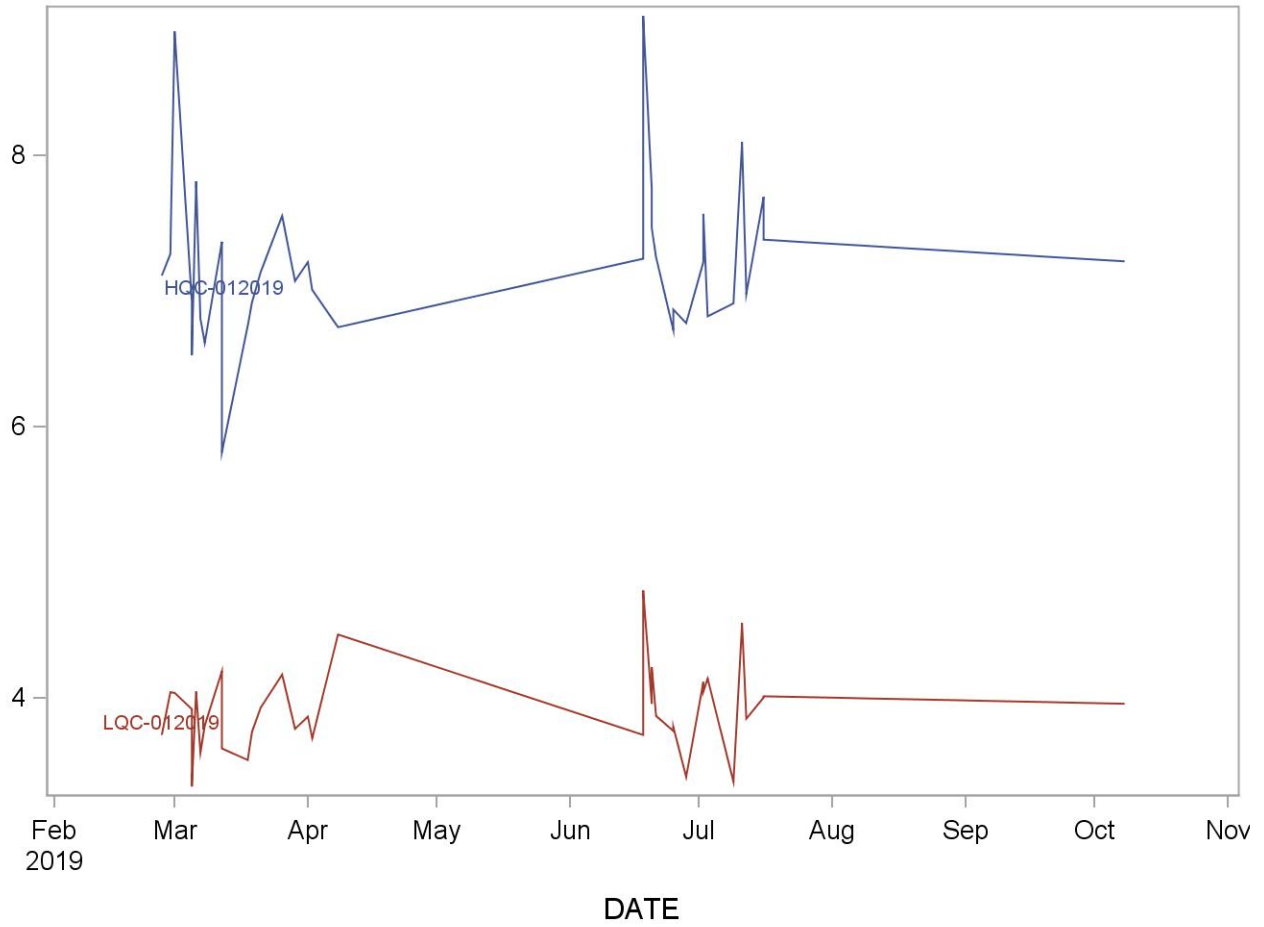

Summary Statistics and QC Chart for n-perfluorooctanoic acid (ng/mL)

Lot	N	Start Date	End Date	Mean	Standard Deviation	Coefficient of Variation
HQC-012019	35	26FEB19	08OCT19	5.7223	0.4322	7.6
LQC-012019	35	26FEB19	08OCT19	2.3767	0.2403	10.1

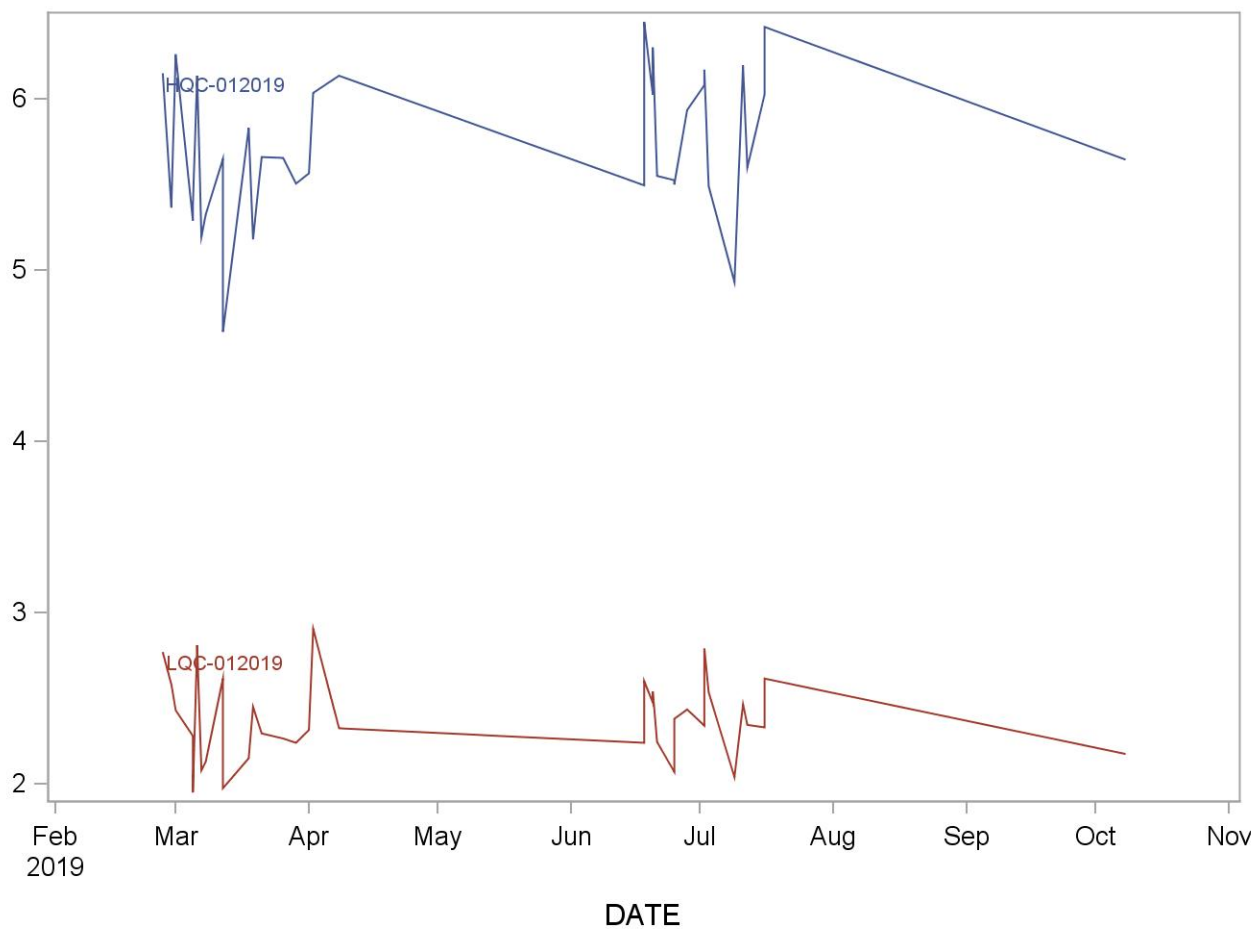

References

1. Agency for Toxic Substances and Disease Registry (ATSDR); Department of Health and Human Services; Public Health Service, Toxicological profile for Perfluoroalkyls. (Draft for Public Comment). Atlanta, Ga, 2018.
2. Houde, M.; Martin, J. W.; Letcher, R. J.; Solomon, K. R.; Muir, D. C., Biological monitoring of polyfluoroalkyl substances: A review. *Environ Sci Technol* **2006**, *40* (11), 3463-73.
3. Calafat, A. M.; Needham, L. L.; Kuklennyik, Z.; Reidy, J. A.; Tully, J. S.; Aguilar-Villalobos, M.; Naeher, L. P., Perfluorinated chemicals in selected residents of the American continent. *Chemosphere* **2006**, *63* (3), 490-6.
4. Guruge, K. S.; Taniyasu, S.; Yamashita, N.; Wijeratna, S.; Mohotti, K. M.; Seneviratne, H. R.; Kannan, K.; Yamanaka, N.; Miyazaki, S., Perfluorinated organic compounds in human blood serum and seminal plasma: a study of urban and rural tea worker populations in Sri Lanka. *J Environ Monit* **2005**, *7* (4), 371-7.
5. Olsen, G. W.; Huang, H. Y.; Helzlsouer, K. J.; Hansen, K. J.; Butenhoff, J. L.; Mandel, J. H., Historical comparison of perfluorooctanesulfonate, perfluorooctanoate, and other fluorochemicals in human blood. *Environ Health Perspect* **2005**, *113* (5), 539-45.
6. Taniyasu, S.; Kannan, K.; Horii, Y.; Hanari, N.; Yamashita, N., A survey of perfluorooctane sulfonate and related perfluorinated organic compounds in water, fish, birds, and humans from Japan. *Environ Sci Technol* **2003**, *37* (12), 2634-9.
7. Karrman, A.; Mueller, J. F.; van Bavel, B.; Harden, F.; Toms, L. M.; Lindstrom, G., Levels of 12 perfluorinated chemicals in pooled australian serum, collected 2002-2003, in relation to age, gender, and region. *Environ Sci Technol* **2006**, *40* (12), 3742-8.
8. Yeung, L. W.; So, M. K.; Jiang, G.; Taniyasu, S.; Yamashita, N.; Song, M.; Wu, Y.; Li, J.; Giesy, J. P.; Guruge, K. S.; Lam, P. K., Perfluorooctanesulfonate and related fluorochemicals in human blood samples from China. *Environ Sci Technol* **2006**, *40* (3), 715-20.
9. Harada, K.; Koizumi, A.; Saito, N.; Inoue, K.; Yoshinaga, T.; Date, C.; Fujii, S.; Hachiya, N.; Hirose, I.; Koda, S.; Kusaka, Y.; Murata, K.; Omae, K.; Shimbo, S.; Takenaka, K.; Takeshita, T.; Todoriki, H.; Wada, Y.; Watanabe, T.; Ikeda, M., Historical and geographical aspects of the increasing perfluorooctanoate and perfluorooctane sulfonate contamination in human serum in Japan. *Chemosphere* **2007**, *66* (2), 293-301.
10. Calafat, A. M.; Wong, L. Y.; Kuklennyik, Z.; Reidy, J. A.; Needham, L. L., Polyfluoroalkyl chemicals in the U.S. population: data from the National Health and Nutrition Examination Survey (NHANES) 2003-2004 and comparisons with NHANES 1999-2000. *Environ Health Perspect* **2007**, *115* (11), 1596-602.
11. Fromme, H.; Midasch, O.; Twardella, D.; Angerer, J.; Boehmer, S.; Liebl, B., Occurrence of perfluorinated substances in an adult German population in southern Bavaria. *Int Arch Occup Environ Health* **2007**, *80* (4), 313-9.
12. Hansen, K. J.; Clemen, L. A.; Ellefson, M. E.; Johnson, H. O., Compound-specific, quantitative characterization of organic fluorochemicals in biological matrices. *Environ Sci Technol* **2001**, *35* (4), 766-70.

13. Kannan, K.; Corsolini, S.; Falandysz, J.; Fillmann, G.; Kumar, K. S.; Loganathan, B. G.; Mohd, M. A.; Olivero, J.; Van Wouwe, N.; Yang, J. H.; Aldoust, K. M., Perfluorooctanesulfonate and related fluorochemicals in human blood from several countries. *Environ Sci Technol* **2004**, *38* (17), 4489-95.
14. Olsen, G. W.; Mair, D. C.; Church, T. R.; Ellefson, M. E.; Reagen, W. K.; Boyd, T. M.; Herron, R. M.; Medhdizadehkashi, Z.; Nobiletti, J. B.; Rios, J. A.; Butenhoff, J. L.; Zobel, L. R., Decline in perfluorooctanesulfonate and other polyfluoroalkyl chemicals in American Red Cross adult blood donors, 2000-2006. *Environ Sci Technol* **2008**, *42* (13), 4989-95.
15. Calafat, A. M.; Kuklennyik, Z.; Reidy, J. A.; Caudill, S. P.; Tully, J. S.; Needham, L. L., Serum concentrations of 11 polyfluoroalkyl compounds in the u.s. population: data from the national health and nutrition examination survey (NHANES). *Environ Sci Technol* **2007**, *41* (7), 2237-42.
16. Kennedy, G. L., Jr.; Butenhoff, J. L.; Olsen, G. W.; O'Connor, J. C.; Seacat, A. M.; Perkins, R. G.; Biegel, L. B.; Murphy, S. R.; Farrar, D. G., The toxicology of perfluorooctanoate. *Crit Rev Toxicol* **2004**, *34* (4), 351-84.
17. Lau, C.; Butenhoff, J. L.; Rogers, J. M., The developmental toxicity of perfluoroalkyl acids and their derivatives. *Toxicol Appl Pharmacol* **2004**, *198* (2), 231-41.
18. Organisation for Economic Co-operation and Development (OECD) Co-Operation on Existing Chemicals. Hazard assessment of perfluorooctane sulfonate (PFOS) and its salts. <http://www.oecd.org/chemicalsafety/risk-assessment/2382880.pdf>.
19. Butenhoff, J. L.; Kennedy, G. L., Jr.; Frame, S. R.; O'Connor, J. C.; York, R. G., The reproductive toxicology of ammonium perfluorooctanoate (APFO) in the rat. *Toxicology* **2004**, *196* (1-2), 95-116.
20. Luebker, D. J.; York, R. G.; Hansen, K. J.; Moore, J. A.; Butenhoff, J. L., Neonatal mortality from in utero exposure to perfluorooctanesulfonate (PFOS) in Sprague-Dawley rats: dose-response, and biochemical and pharmacokinetic parameters. *Toxicology* **2005**, *215* (1-2), 149-69.
21. Salihovic, S.; Kärrman, A.; Lindström, G.; Lind, P. M.; Lind, L.; van Bavel, B., A rapid method for the determination of perfluoroalkyl substances including structural isomers of perfluorooctane sulfonic acid in human serum using 96-well plates and column-switching ultra-high performance liquid chromatography tandem mass spectrometry. *Journal of chromatography. A* **2013**, *1305*, 164-70.
22. Gordon, S. C., Toxicological evaluation of ammonium 4,8-dioxa-3H-perfluorononanoate, a new emulsifier to replace ammonium perfluorooctanoate in fluoropolymer manufacturing. *Regulatory Toxicology and Pharmacology* **2011**, *59* (1), 64-80.
23. Wang, S. W.; Huang, J.; Yang, Y.; Hui, Y. M.; Ge, Y. X.; Larssen, T.; Yu, G.; Deng, S. B.; Wang, B.; Harman, C., First Report of a Chinese PFOS Alternative Overlooked for 30 Years: Its Toxicity, Persistence, and Presence in the Environment. *Environmental Science & Technology* **2013**, *47* (18), 10163-10170.
24. Gannon, S. A.; Fasano, W. J.; Mawn, M. P.; Nabb, D. L.; Buck, R. C.; Buxton, L. W.; Jepson, G. W.; Frame, S. R., Absorption, distribution, metabolism, excretion, and kinetics of 2,3,3,3-tetrafluoro-2-(heptafluoropropoxy)propanoic acid ammonium salt

- following a single dose in rat, mouse, and cynomolgus monkey. *Toxicology* **2016**, *340*, 1-9.
25. Gebbink, W. A.; Van Asseldonk, L.; Van Leeuwen, S. P. J., Presence of Emerging Per- and Polyfluoroalkyl Substances (PFASs) in River and Drinking Water near a Fluorochemical Production Plant in the Netherlands. *Environmental Science & Technology* **2017**, *51* (19), 11057-11065.
26. Heydebreck, F.; Tang, J.; Xie, Z.; Ebinghaus, R., Alternative and Legacy Perfluoroalkyl Substances: Differences between European and Chinese River/Estuary Systems. *Environmental Science & Technology* **2015**, *49* (14), 8386-8395.
27. Sun, M.; Arevalo, E.; Strynar, M.; Lindstrom, A.; Richardson, M.; Kearns, B.; Pickett, A.; Smith, C.; Knappe, D. R. U., Legacy and Emerging Perfluoroalkyl Substances Are Important Drinking Water Contaminants in the Cape Fear River Watershed of North Carolina. *Environmental Science & Technology Letters* **2016**, *3* (12), 415-419.
28. Liu, H.; Wang, J.; Sheng, N.; Cui, R.; Pan, Y.; Dai, J., Acot1 is a sensitive indicator for PPAR+Y activation after perfluorooctanoic acid exposure in primary hepatocytes of Sprague-Dawley rats. *Toxicology in Vitro* **2017**, *42*, 299-307.
29. Wang, Z.; Cousins, I. T.; Berger, U.; Hungerbuhler, K.; Scheringer, M., Comparative assessment of the environmental hazards of and exposure to perfluoroalkyl phosphonic and phosphinic acids (PFPA and PFPiAs): Current knowledge, gaps, challenges and research needs. *Environment International* **2016**, *89-90*, 235-247.
30. Deng, M.; Wu, Y.; Xu, C.; Jin, Y.; He, X.; Wan, J.; Yu, X.; Rao, H.; Tu, W., Multiple approaches to assess the effects of F-53B, a Chinese PFOS alternative, on thyroid endocrine disruption at environmentally relevant concentrations. *Sci Total Environ* **2017**, *624*, 215-224.
31. Kuklennyik, Z.; Needham, L. L.; Calafat, A. M., Measurement of 18 perfluorinated organic acids and amides in human serum using on-line solid-phase extraction. *Analytical chemistry* **2005**, *77* (18), 6085-91.
32. White, S. S.; Kato, K.; Jia, L. T.; Basden, B. J.; Calafat, A. M.; Hines, E. P.; Stanko, J. P.; Wolf, C. J.; Abbott, B. D.; Fenton, S. E., Effects of perfluorooctanoic acid on mouse mammary gland development and differentiation resulting from cross-foster and restricted gestational exposures. *Reprod Toxicol* **2009**, *27* (3-4), 289-298.
33. Centers for Disease Control and Prevention; National Center for Environmental Health; Division of Laboratory Sciences, Division of Laboratory Sciences Policies and Procedures Manual, Version 6. Atlanta, GA, 2017.
34. Caudill, S. P.; Schleicher, R. L.; Pirkle, J. L., Multi-rule quality control for the age-related eye disease study. *Statistics in medicine* **2008**, *27* (20), 4094-106.
35. Centers for Disease Control and Prevention; National Center for Environmental Health; Division of Laboratory Sciences; Fourth National Report on Human Exposure to Environmental Chemicals, Updated Tables, January 2019.